



2024 Product Guide

WALDEN

PREMIER



ABOUT THE COLLECTION

The Walden Premier Collection includes contemporary patterns, with bamboos that have been reimagined for modern decor, woven jutes in trending neutrals and white color choices, and soft, natural fabrics.

Using natural shades in your design is a subtle way to bring the timeless beauty of nature into your space.

Shades incorporate natural fibers like bamboo, jute, and ramie into their weaves, which are selected based on color and luster. Materials are hand processed and woven into shade fabric. Finished fabrics highlight the textures, colors, and qualities of the natural materials used to create them.

After drying and quality review, fabrics are then sewn and constructed by hand into finished shades.

All the patterns in this collection can be made into roman shades. Many can be made into folding doors or sliding panels.

Natural shades are as functional as they are beautiful with several customization options available including the ability to tailor your light and privacy preferences with various liner and shade styles.

The collection has three unique cord-free control options: our patented cordless system that can lift even the heaviest shade on a 1½" head rail and our affordable, versatile wand and remote control motorization options.

Our Limited Lifetime Warranty covers all aspects of workmanship and quality in your shades.

TABLE OF CONTENTS

MATERIALS REFERENCE TABLES

| | |
|--|-------|
| Woven Wood Materials Reference | 4 - 5 |
| Edge Binding / Liner Materials Reference | 5 |

SHADE CONSTRUCTION

| | |
|-------------------------------|---|
| Shade Styles | 6 |
| Shade Options | 7 |

CONTROL OPTIONS

| | |
|------------------------------|----|
| Cordless | 8 |
| Clutch | 9 |
| Wand Motor | 10 |
| Remote Motor | 11 |

DESIGN OPTIONS

| | |
|--|----|
| Attached Liners | 12 |
| Movable Liners | 12 |
| Multiple Shades on One Head Rail | 13 |
| Back/Interior Valance | 13 |
| Top-Down Bottom-Up | 13 |
| Hold Down Brackets and Spacer Blocks | 14 |
| Valance Only | 14 |

SHADE SPECIFICATIONS

| | |
|---|----|
| Specifications Table | 15 |
| Specification Line Drawings | 15 |

SHADE PRICING

| | |
|---------------------------------|---------|
| Shade Grids | 16 - 18 |
| Options Pricing | 19 - 21 |

FOLDING DOORS

| | |
|--------------------------------|---------|
| Styles | 22 |
| Options | 23 |
| Specifications | 24 |
| Pricing | 25 - 27 |

SLIDING PANELS

| | |
|---|---------|
| Styles | 28 |
| Options | 29 |
| Specifications / Configurations | 30 - 31 |
| Pricing | 32 - 34 |

WARRANTY

| | |
|---|----|
| Limited Lifetime Warranty | 36 |
|---|----|



MATERIALS REFERENCE TABLES

| CODE | PATTERN NAME | PRICE GROUP | EDGE BINDING REQUIRED | CORDLESS TDBU | SLIDING PANEL | FOLDING DOOR | COORDINATED WAND COLOR | COORDINATED EDGE BINDING COLOR | MAXIMUM SIZE MOTORIZED ⁽¹⁾ (SQUARE FEET) | |
|---------|--------------------|-------------|-----------------------|---------------|---------------|--------------|------------------------|--------------------------------|---|----------|
| | | | | | | | | | W/O LINER | W/ LINER |
| E-M01 | Aires White | F | N | Y | Y | N | White | Chalk | 64 | 64 |
| E-87K | Alder Oak | B | N | N | Y | Y | Beige | Camel | 44 | 38 |
| E-232W | Andell Linen | F | Y | Y | N | N | Beige | Stone | 64 | 64 |
| E-432 | Artisan Weave | E | N | N | N | N | Bronze | Stone | 44 | 38 |
| E-416-3 | Aspen Ebony | C | N | N | Y | Y | Black | Brown | 44 | 38 |
| E-082 | Aspen Walnut | C | N | N | Y | Y | Bronze | Brown | 44 | 38 |
| E-416-4 | Aspen White | C | N | N | Y | Y | White | Chalk | 44 | 38 |
| E-234G | Avon Dawn | F | Y | Y | N | N | Beige | Stone | 64 | 64 |
| E-234W | Avon Lace | F | Y | Y | N | N | White | Chalk | 64 | 64 |
| E-R26 | Bamboo Forest | B | N | N | Y | Y | Bronze | Camel | 44 | 38 |
| E-365 | Barcelona Café | B | N | N | Y | Y | Bronze | Camel | 54 | 44 |
| E-861 | Bora Bora | B | N | N | Y | Y | Beige | Camel | 50 | 42 |
| E-430 | Capri Natural | D | N | Y | Y | N | Beige | Camel | 64 | 56 |
| E-233B | Castelo Black | D | N | Y | N | N | Black | Midnight | 64 | 56 |
| E-233P | Castelo White | D | N | Y | N | N | White | Chalk | 64 | 56 |
| E-389 | Catalina | E | N | Y | Y | N | Beige | Linen | 64 | 64 |
| E-E11 | Devon Ivory | A | N | Y | Y | Y | Beige | Linen | 56 | 45 |
| E-E06 | Devon Maple | A | N | Y | Y | Y | Beige | Cedar | 56 | 45 |
| E-E02 | Devon White | A | N | Y | Y | Y | White | Chalk | 56 | 45 |
| E-68N | Driftwood Natural | B | N | N | Y | Y | Beige | Linen | 44 | 38 |
| E-055 | Java Cocoa | B | N | Y | Y | Y | Bronze | Brown | 54 | 44 |
| E-B01 | Mandalay Umber | C | N | N | Y | Y | Black | Brown | 33 | 30 |
| E-801 | Mykonos Dunes | F | N | Y | Y | N | Beige | Linen | 64 | 56 |
| E-390 | Natural Jute | E | N | Y | Y | N | Beige | Linen | 64 | 56 |
| E-803 | Navarre White Sand | F | N | Y | Y | N | White | Linen | 64 | 56 |
| E-P01 | Orleans Macaroon | E | N | Y | N | N | White | Chalk | 64 | 64 |
| E-403-B | Penang Oak | A | N | N | Y | Y | Bronze | Camel | 56 | 45 |
| E-427 | Prairie Golden | E | N | Y | Y | N | Beige | Linen | 64 | 56 |
| E-828 | Prairie Snow | F | N | Y | Y | N | Beige | Linen | 64 | 56 |
| E-428 | Prairie White | E | N | Y | Y | N | Beige | Linen | 64 | 56 |
| E-M04 | Remi Breeze | E | N | Y | Y | N | Beige | Stone | 64 | 56 |
| E-233W | Rhone Blanc | E | N | Y | N | N | White | Chalk | 64 | 64 |
| E-001 | Sakura Oregano | C | N | Y | Y | N | Bronze | Cedar | 54 | 44 |
| E-352 | Savanna Husk | C | N | Y | Y | N | Bronze | Camel | 64 | 56 |
| E-U01 | Saybrook Stone | E | N | Y | Y | N | Gray | Cedar | 56 | 45 |
| E-U03 | Seaside White | F | N | Y | Y | N | Beige | Stone | 56 | 45 |
| E-370 | Sierra Sand | D | N | N | N | N | Bronze | Camel | 50 | 42 |
| E-438 | Sunshade Brown | A | N | N | Y | Y | Bronze | Camel | 54 | 48 |
| E-10H | Sunshade White | C | N | N | Y | Y | White | Chalk | 44 | 38 |
| E-394 | Tamarind Sunset | B | N | N | Y | Y | Bronze | Camel | 44 | 38 |

All patterns have a maximum width of 96".

⁽¹⁾Motorized square foot size restrictions do not apply to Power Lift motors.

MATERIALS REFERENCE TABLES

| CODE | PATTERN NAME | PRICE GROUP | EDGE BINDING REQUIRED | CORDLESS TDBU | SLIDING PANEL | FOLDING DOOR | COORDINATED WAND COLOR | COORDINATED EDGE BINDING COLOR | MAXIMUM SIZE MOTORIZED ⁽¹⁾ (SQUARE FEET) | |
|--------|-------------------|-------------|-----------------------|---------------|---------------|--------------|------------------------|--------------------------------|---|----------|
| | | | | | | | | | W/O LINER | W/ LINER |
| E-805 | Telluride Frost | D | N | Y | Y | Y | White | Chalk | 44 | 38 |
| E-806 | Telluride Thunder | D | N | Y | Y | Y | Beige | Stone | 44 | 38 |
| E-2203 | Twyla Cascade | E | N | Y | Y | Y | Beige | Stone | 56 | 45 |
| E-2201 | Twyla Cotton | E | N | Y | Y | Y | White | Chalk | 56 | 45 |
| E-2104 | Zahra Dark Olive | F | N | Y | Y | Y | Bronze | Cedar | 64 | 56 |
| E-2103 | Zahra Sepia | F | N | Y | Y | Y | Bronze | Cedar | 64 | 56 |
| E-2102 | Zahra Sorbet | F | N | Y | Y | Y | Beige | Stone | 64 | 56 |

All patterns have a maximum width of 96".

⁽¹⁾ Motorized square foot size restrictions do not apply to Power Lift motors.

EDGE BINDINGS

Twill Tape

| CODE | COLOR |
|---------------------|-------------|
| NARROW EDGE BINDING | |
| N3 | Beige |
| N10 | Black |
| N4 | Chocolate |
| N5 | Copper |
| N8 | Cream |
| N6 | Desert Sand |
| N2 | Light Beige |
| N15 | Natural |
| N11 | Sienna |
| N1 | White |
| WIDE EDGE BINDING | |
| W3 | Beige |
| W10 | Black |
| W4 | Chocolate |
| W5 | Copper |
| W8 | Cream |
| W6 | Desert Sand |
| W2 | Light Beige |
| W15 | Natural |
| W11 | Sienna |
| W1 | White |

Narrow Twill Tape Edge Binding will show ½" on the face of the shade.

Wide Twill Tape Edge Binding will show 1½" on the face of the shade.

Ramie

| CODE | COLOR |
|------|----------|
| NL4 | Brown |
| NL35 | Camel |
| NL88 | Cedar |
| NL1 | Chalk |
| NL3 | Graphite |
| NL2 | Linen |
| NL7 | Midnight |
| NL6 | Navy |
| NL71 | Stone |
| NL33 | Titanium |

Ramie Edge Binding will show ½" on the face of the shade.

LINERS

| CODE | COLOR |
|------------------------|-----------|
| LIGHT-FILTERING LINERS | |
| NK-L | Beige |
| NB-L | Black |
| NC-L | Chocolate |
| NG-L | Gray |
| W4-L | White |
| BLACK-OUT LINERS | |
| K3-D | Beige |
| C2-D | Chocolate |
| W4-D | White |

SHADE STYLES

PATTERN SELECTION

The Materials Reference table provides useful technical information about each pattern and also identifies which price chart you should use. Coordinated edge binding and wand colors are also listed for each pattern.

The fabrics in this collection are made from natural materials, which are subject to variation in color, texture, and weave. Like any natural product, fabrics may show natural color changes over time.

Woven wood fabrics are not ideal for rooms with excessive humidity like bathrooms. Shades installed in these environments may bow or twist over time.

SHADE STYLES

Shades come in two basic shade styles: standard and waterfall.

STANDARD SHADES

Material is attached to the back of the head rail. Shade includes a 6" valance to conceal the components. When raised, the material rises from the bottom in flat folds.

WATERFALL SHADES

Material is attached to the front of the head rail, without a valance. When raised, the material rises from the bottom in flat folds. Optional back valance is available upon request.

Clutch shades will have the cord loop behind the shade.

BOTTOM BARS

Clutch and motorized shades will be made with a round fabric wrapped bottom bar.

Cordless shades are made with a rectangular fabric wrapped bottom bar.



Standard Shade
with valance



Waterfall Shade
without valance

SHADE OPTIONS

EDGE BINDING

Edge binding is available for all patterns.

Edge binding is applied to the sides of both the shade and valance. It is not applied to the bottom of either.

Edge bindings are available in the following styles:

- Narrow Twill Tape (shows ½" on the face of the shade)
- Wide Twill Tape (shows 1½" on the face of the shade)
- Ramie (shows ½" on the face of the shade)

Some patterns are required to be ordered with edge binding, as noted in the Materials Reference table. Patterns that require edge binding will have the warranty for frayed edges voided if ordered without edge binding.



Edge Binding
shown with narrow twill tape

VALANCE RETURNS

Outside mount shades are recommended to be ordered with valance returns. Returns for both outside and inside mount shades are available free of charge if requested when the order is placed.

Standard valance returns are made using the shade material. Valance returns can also be made using edge binding fabric for a surcharge.

Standard valance return height will be 1½" less than the valance height. This length will keep the rolled bottom of the valance from interfering with the return.

Optional short valance returns are also available. Short returns cover the end of the head rail and hide the shade components, keeping the stack of the raised shade away from the returns.

Custom valance return lengths are available to be ordered upon request.

All valance returns will be made with an L-shaped connector to attach to the back of the valance. This holds the returns in place and creates a clean, finished corner.



Standard Length Valance Return

CONTROL OPTIONS

CORDLESS SHADES

Cordless shades are raised by pushing up on the hem bar and lowered by pulling down on the hem bar. A spring control system located under the wooden head rail holds the shade in place at the desired position.

Clear grips are added to the hem bar of cordless shades, one per shade up to 72" wide and two for wider shades.

Cordless shades are available up to 96" wide and 96" long and will be mounted on a 1½" deep head rail (see Specifications for details).



Cordless Shade

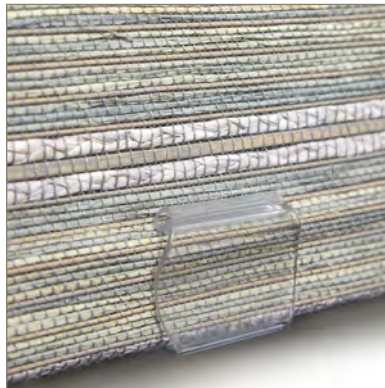

Clear Grip

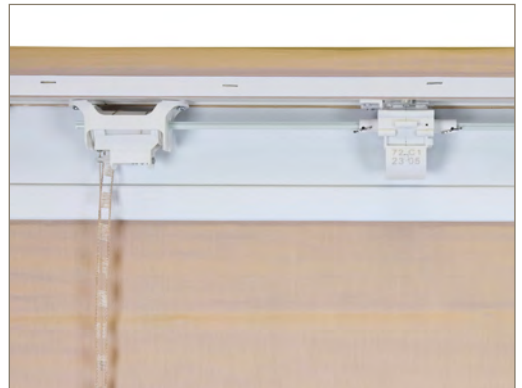

Cordless Spring and Spool

CONTROL OPTIONS

CLUTCH CONTROLS

Clutches provide an assisted lift for large or heavy shades and come standard with metal chain loops. Metal chain loops can be made in custom lengths.

Compliant cord tensioners are provided with clutch control shades. Cord tensioners secure the cord loop to the wall or window. They must be installed so the shade is compliant with safety regulations and operates correctly.

Standard shades ordered with a clutch come “clutch adjacent” to keep the stack of the raised shade from interfering with the loop. This means the shade fabric will be narrower than the ordered width on the control side, allowing the cord to hang to the side of the shade (see diagram). This may cause a light gap on black-out shades.

Waterfall shades ordered with clutch controls will have control loops behind the shade and are not available to be ordered as clutch adjacent.



Clutch Shade with cord loop



Fabric Deduction

| | 7/8" shade fabric deduction

1 1/8" shade fabric deduction for shades ordered with returns

CONTROL OPTIONS

WAND CONTROL SHADES

Wand control motorized shades are powered by an internal, rechargeable lithium-ion battery. The motor is controlled using a wand, which hangs to the side of the shade.

Waterfall shades cannot be ordered with wand controls.

Wands come in four lengths: 24", 36", 48", and 60". Available colors include white, beige, gray, bronze, and black.

Wand control shade motor batteries are recharged via a standard micro-USB power adaptor, which plugs into the end of the wand.

Motorized shades will be mounted on a deeper head rail (see Specifications for details).

All wand control shades will be made with the shade fabric on the control side $\frac{5}{8}$ " narrower for shades without returns and $\frac{7}{8}$ " narrower for shades with returns than the ordered width, allowing the wand to hang to the side of the shade. This may cause a light gap on the control side of inside mount shades with black-out liner.



Wand Shade



Wand Control with Micro-USB power adaptor



Wand Control Colors: White, Beige, Gray, Bronze, and Black



Fabric Deduction

CONTROL OPTIONS

REMOTE CONTROL SHADES

Remote motors have rechargeable and hardwired options available, which can be controlled with remotes, wall switches, or motor hubs.

See Specifications for minimum widths by motor type.



Remote
(multi-channel)



Wall Switch
(multi-channel)



Remote Control Shade and Motor Head

REMOTE MOTOR OPTIONS

| | RECHARGEABLE LITHIUM ION | 12 V DC HARDWIRED | 12 V DC EXTERNAL POWER | 100-240 AC HARDWIRED* |
|--------------|---|---|--|--|
| MOTOR TYPE | Standard Lift Power Lift | Standard Lift | Standard Lift | Standard Lift |
| POWER SUPPLY | Internal | Hardwired | AA Battery Tube External LI Battery Pack | Hardwired <i>AC wall plug not available through this collection</i> |
| CHARGER | 6'/16½' Micro-USB | - | 6'/16½' Micro-USB <i>Used to recharge LI Battery Pack</i> | - |
| REMOTE | Single/15 Channel Remote Single/15 Channel Wall Switch | 15 Channel Remote 15 Channel Wall Switch | 15 Channel Remote 15 Channel Wall Switch | 15 Channel Remote 15 Channel Wall Switch |
| AUTOMATION | Pro Hub | Pro Hub | Pro Hub | Pro Hub |

*Requires installation by an electrician.

PRO HUB

Connects through 2.4 GHz wifi or directly to router with ethernet cable.

Works with Connector+ App, Amazon Alexa, Control4, Google Home, IFTTT, RTI, Samsung Smart Things, and Siri Short Cuts.



Pro Hub

DESIGN OPTIONS

ATTACHED LINERS

Attached liners are secured on the back of the shade. Shades will have liner fabric tacked to the back of the shade fabric.

If a shade is lined, the valance will automatically be lined with the same liner style and color. Unlined shades will be made with a lined valance to conceal the lift mechanisms.

Many patterns let a lot of light through and offer little privacy at night. We recommend ordering shades with liners when light control or privacy is desired.



No Liner

Light-Filtering Liner

Black-Out Liner

MOVABLE LINERS

Shades with movable liners (or twin shades) are shades with a separate, operable liner and two sets of controls: one for the woven wood shade in front and one for the liner shade behind. Controls can be on the same side or on opposite sides of the shade.

Controls can also be a mix of cordless, clutch, or motorized controls. When using clutch control, cord loops for the liner shade will always be positioned behind the front shade. When using wand motorization, wand motor must be used for both the front and back shade.

Outside mount twin shades will be made with a valance that is $\frac{3}{4}$ " wider than the ordered shade width. This will allow the returns to fit behind the valance.

Twin shades have deeper head rails to accommodate the dual sets of controls (see Specifications for details).

Twin Shades are not available as TDBU or 3-on-1 head rail.

DESIGN OPTIONS

MULTIPLE SHADES ON ONE HEAD RAIL

Shades are available with 2-on-1 or 3-on-1 head rail. The maximum total width is 108". The gap between shades will be no more than ½". The maximum width for a common valance is 96"; wider valances will be made in sections to match the individual shade widths.

Clutches, cordless controls, and motorization (wand or remote) can be used for these shades. When ordered with clutch control, pay careful attention to make sure there are suitable locations for chain tensioners when specifying multiple shades on one head rail, particularly for the middle shade in 3-on-1 head rail units.

Available for standard shades and TDBU shades. Not available for shades with a movable liner.

BACK VALANCE/INTERIOR VALANCE (WATERFALL SHADES)

Back valances for waterfall shades are available upon request and can be ordered in either the shade fabric or the liner fabric for lined shades. Back valances conceal the shade components from the back of the shade.

Interior valances come standard with waterfall shades that are unlined or that are ordered with a light-filtering liner. Interior valances block the outline of the shade components from showing on the front of the shade. Valances are 4" long and are made with black-out White (W4-D) liner material. Because the valance is made with black-out fabric, the part of the shade in front of the interior valance will look darker than the rest of the shade when light is coming through.



Waterfall Shade with interior and back valances

TOP-DOWN BOTTOM-UP

Top-down bottom-up (TDBU) shades can be raised from the bottom or lowered from the top. To conceal shade components, shades will be finished with a black-out lined front valance and back valance. Back valance will match shade material for unlined shades or liner material for lined shades.

Outside mount TDBU shades will be made with a valance that is ¾" wider than the ordered shade width, allowing the returns to fit behind the valance.

TDBU shades are not available in waterfall style or as twin shades.

Only available with cordless control.

Check the Materials Reference table for patterns that are available to be made as TDBU.



Top Down Bottom Up Shade

DESIGN OPTIONS

HOLD DOWN BRACKETS AND SPACER BLOCKS

Hold down brackets are supplied upon request for all control types.

Spacer blocks measuring 3/8" are available upon request with a maximum of 2 spacer blocks per bracket recommended.



Hold Down Bracket

VALANCE ONLY

Valance Only is available for all fabrics. Valances can be specified in length up to 18" long and have a maximum width of 96". Check the Materials Reference table for maximum fabric width by pattern.

Valance returns will be made to the ordered length of the valance or can be requested in custom lengths.

Valances can be ordered attached to a head rail or loose. Available head rail depths for attached valances are 1", 1½", 2¾", 3½", or 4½".

Valances can be made with liners and edge binding for a surcharge. Please specify if valances should be lined or unlined and made with or without edge binding when placing your order.

SPECIFICATIONS

| | MINIMUM WIDTH | MAXIMUM WIDTH | MINIMUM HEIGHT | MAXIMUM HEIGHT | IB DEDUCTION (width) | FLUSH IB DEPTH ⁽¹⁾ (top mount w/brkt) | MINIMUM IB DEPTH (top mount w/brkt) |
|------------------------------|---------------|---------------|----------------|----------------|----------------------|--|-------------------------------------|
| CORDLESS | 15" | 96" | 18" | 96" | 3/8" | 2 1/2" | 3/4" |
| CORDLESS TDBU ⁽²⁾ | 18" | 60" | 18" | 72" | 3/8" | 2 1/2" | 3/4" |
| CLUTCH and LOOP | 14" | 96" | 18" | 108" | 3/8" | 2 1/2" | 3/4" |
| WAND CONTROL | 23" | 96" | 18" | 108" | 3/8" | 3 3/4" | 3/4" |
| Remote Control Motors | 23" | 96" | 18" | 108" | 3/8" | 3 3/4" | 3/4" |
| • STANDARD LI | | | | | | | |
| • STANDARD DC MOTOR | 15" | 96" | 18" | 108" | 3/8" | 3 3/4" | 3/4" |
| • STANDARD AC MOTOR | 20" | 96" | 18" | 108" | 3/8" | 3 3/4" | 3/4" |
| • POWER LIFT LI MOTOR | 29 1/2" | 96" | 18" | 108" | 3/8" | 3 3/4" | 3/4" |
| 2-ON-1 / 3-ON-1 | - | 108" total | - | - | - | - | - |
| COMMON VALANCE | - | 96" | - | - | - | - | - |
| VALANCE ONLY | - | 96" | - | 18" | - | - | - |

⁽¹⁾ Flush IB depth is head rail depth plus 1" when using standard bracket. Exact measurement will vary slightly based upon fabric thickness.

⁽²⁾ See the Materials Reference table for fabrics available to order with cordless TDBU control.

BRACKET DIMENSIONS

Height: 1 1/2"

Depth: 1 3/4"

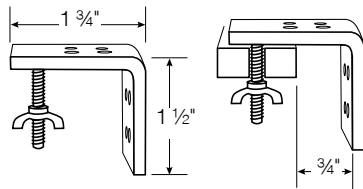

RING SPACING AND STACK HEIGHT

Ring spacing: First fold starts at 3/2" above the bottom bar, then rings are spaced 7" apart on back of the shade.

Stack height (all lengths): 8" to 10"

HEAD RAIL DIMENSIONS

Middle support brackets will be supplied for all shades over 41" wide.

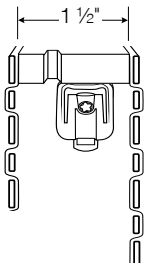

CORDLESS

- Standard Shades
- Waterfall Shades
- TDBU

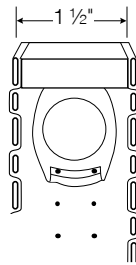

CLUTCH

- with Continuous Chain Loop
- Standard Shades
- Waterfall Shades

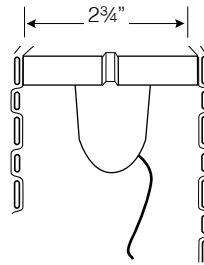

MOTORIZED

- Standard Shades
- Waterfall Shades
- Wand or Remote Control

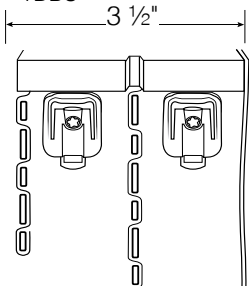

Woven Wood Shade

Movable Liner

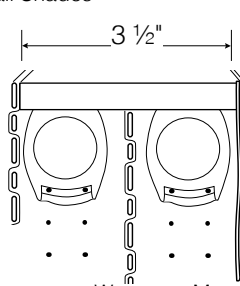

Woven Wood Shade

Movable Liner

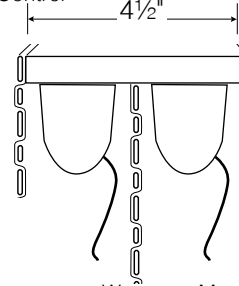

Woven Wood Shade

Movable Liner

TWIN SHADE W/CORDLESS

- Standard Shades
- Waterfall Shades

TWIN SHADE W/ TWO CLUTCHES

- Controls Same Side (shown) or Opposite Sides
- Standard Shades
- Waterfall Shades

TWIN SHADE W/ TWO MOTORS

- Controls Same Side (shown) or Opposite Sides
- Standard Shades
- Waterfall Shades
- Wand or Remote Control

SHADE PRICING

Includes Cordless and Clutch control shades.

| PRICE GROUP A | | WIDTH | | | | | | | | | |
|-----------------------------------|--------|--------------------|-------|-------|-------|-------|-------|-------|---------|---------|---------|
| | | 24" | 30" | 36" | 42" | 48" | 60" | 72" | 84" | 96" | |
| DEVON PENANG SUNSHADE BROWN | LENGTH | 36" | \$278 | \$284 | \$321 | \$345 | \$371 | \$465 | \$506 | \$587 | \$629 |
| | | 48" | \$302 | \$331 | \$358 | \$391 | \$420 | \$530 | \$576 | \$672 | \$724 |
| | | 54" | \$315 | \$358 | \$378 | \$410 | \$449 | \$563 | \$620 | \$712 | \$774 |
| | | 60" | \$327 | \$368 | \$400 | \$431 | \$463 | \$590 | \$666 | \$752 | \$824 |
| | | 66" | \$338 | \$378 | \$420 | \$453 | \$490 | \$653 | \$705 | \$813 | \$893 |
| | | 72" | \$350 | \$394 | \$440 | \$476 | \$513 | \$676 | \$735 | \$874 | \$960 |
| | | 78" | \$366 | \$413 | \$460 | \$505 | \$549 | \$709 | \$784 | \$916 | \$1,010 |
| | | 84" | \$380 | \$431 | \$482 | \$530 | \$586 | \$742 | \$818 | \$960 | \$1,071 |
| | | 96" | \$406 | \$464 | \$523 | \$578 | \$632 | \$825 | \$924 | \$1,076 | \$1,203 |
| | | 108" | \$443 | \$509 | \$575 | \$637 | \$697 | \$910 | \$1,020 | \$1,190 | \$1,332 |
| VALANCE ONLY | | Maximum Length 18" | \$138 | \$142 | \$172 | \$192 | \$213 | \$260 | \$292 | \$340 | \$373 |

| PRICE GROUP B | | WIDTH | | | | | | | | | |
|---|--------|--------------------|-------|-------|-------|-------|-------|-------|---------|---------|---------|
| | | 24" | 30" | 36" | 42" | 48" | 60" | 72" | 84" | 96" | |
| ALDER BAMBOO BARCELONA BORA DRIFTWOOD JAVA TAMARIND | LENGTH | 36" | \$314 | \$335 | \$374 | \$397 | \$420 | \$506 | \$556 | \$651 | \$716 |
| | | 48" | \$357 | \$394 | \$431 | \$463 | \$495 | \$582 | \$638 | \$752 | \$851 |
| | | 54" | \$367 | \$410 | \$452 | \$487 | \$522 | \$617 | \$679 | \$803 | \$901 |
| | | 60" | \$380 | \$426 | \$472 | \$510 | \$548 | \$653 | \$721 | \$851 | \$952 |
| | | 66" | \$394 | \$444 | \$493 | \$535 | \$576 | \$688 | \$764 | \$897 | \$1,000 |
| | | 72" | \$409 | \$462 | \$515 | \$559 | \$604 | \$721 | \$807 | \$943 | \$1,048 |
| | | 78" | \$421 | \$479 | \$536 | \$585 | \$632 | \$757 | \$848 | \$987 | \$1,099 |
| | | 84" | \$434 | \$496 | \$556 | \$608 | \$659 | \$792 | \$890 | \$1,032 | \$1,150 |
| | | 96" | \$464 | \$551 | \$598 | \$657 | \$714 | \$893 | \$1,010 | \$1,165 | \$1,293 |
| | | 108" | \$509 | \$585 | \$658 | \$724 | \$789 | \$986 | \$1,118 | \$1,290 | \$1,432 |
| VALANCE ONLY | | Maximum Length 18" | \$166 | \$183 | \$215 | \$233 | \$251 | \$292 | \$333 | \$390 | \$443 |

SHADE PRICING

Includes Cordless and Clutch control shades.

| PRICE GROUP C | | WIDTH | | | | | | | | | |
|--|--------|--------------------|-------|-------|-------|-------|-------|---------|---------|---------|---------|
| | | 24" | 30" | 36" | 42" | 48" | 60" | 72" | 84" | 96" | |
| ASPEN MANDALAY SAKURA SAVANNA SUNSHADE WHITE | LENGTH | 36" | \$347 | \$378 | \$413 | \$433 | \$472 | \$593 | \$669 | \$808 | \$907 |
| | | 48" | \$373 | \$416 | \$459 | \$486 | \$513 | \$665 | \$752 | \$904 | \$1,039 |
| | | 54" | \$390 | \$437 | \$485 | \$516 | \$546 | \$695 | \$811 | \$970 | \$1,088 |
| | | 60" | \$409 | \$459 | \$507 | \$543 | \$586 | \$744 | \$848 | \$1,010 | \$1,158 |
| | | 66" | \$427 | \$479 | \$530 | \$568 | \$621 | \$792 | \$909 | \$1,079 | \$1,228 |
| | | 72" | \$443 | \$499 | \$553 | \$594 | \$649 | \$850 | \$975 | \$1,157 | \$1,314 |
| | | 78" | \$462 | \$520 | \$579 | \$631 | \$697 | \$891 | \$1,022 | \$1,214 | \$1,383 |
| | | 84" | \$477 | \$540 | \$604 | \$668 | \$731 | \$932 | \$1,071 | \$1,270 | \$1,451 |
| | | 96" | \$510 | \$582 | \$651 | \$721 | \$803 | \$1,039 | \$1,210 | \$1,419 | \$1,610 |
| | | 108" | \$562 | \$642 | \$718 | \$799 | \$890 | \$1,152 | \$1,343 | \$1,575 | \$1,790 |
| VALANCE ONLY | | Maximum Length 18" | \$193 | \$218 | \$246 | \$261 | \$292 | \$363 | \$423 | \$516 | \$595 |

| PRICE GROUP D | | WIDTH | | | | | | | | | |
|---|--------|--------------------|-------|-------|-------|-------|-------|---------|---------|---------|---------|
| | | 24" | 30" | 36" | 42" | 48" | 60" | 72" | 84" | 96" | |
| CAPRI CASTELO SIERRA TELLURIDE | LENGTH | 36" | \$386 | \$400 | \$437 | \$460 | \$482 | \$617 | \$698 | \$840 | \$962 |
| | | 48" | \$397 | \$436 | \$489 | \$519 | \$549 | \$702 | \$800 | \$957 | \$1,092 |
| | | 54" | \$416 | \$472 | \$528 | \$555 | \$582 | \$742 | \$850 | \$1,015 | \$1,160 |
| | | 60" | \$433 | \$500 | \$552 | \$589 | \$614 | \$782 | \$900 | \$1,074 | \$1,226 |
| | | 66" | \$452 | \$516 | \$579 | \$612 | \$647 | \$874 | \$985 | \$1,158 | \$1,322 |
| | | 72" | \$472 | \$530 | \$591 | \$637 | \$681 | \$911 | \$1,048 | \$1,243 | \$1,415 |
| | | 78" | \$486 | \$552 | \$616 | \$712 | \$731 | \$954 | \$1,099 | \$1,304 | \$1,486 |
| | | 84" | \$507 | \$575 | \$642 | \$746 | \$781 | \$999 | \$1,151 | \$1,362 | \$1,560 |
| | | 96" | \$546 | \$622 | \$697 | \$754 | \$849 | \$1,134 | \$1,309 | \$1,551 | \$1,769 |
| | | 108" | \$601 | \$687 | \$771 | \$836 | \$941 | \$1,257 | \$1,455 | \$1,725 | \$1,970 |
| VALANCE ONLY | | Maximum Length 18" | \$224 | \$235 | \$265 | \$283 | \$301 | \$383 | \$446 | \$541 | \$639 |

SHADE PRICING

Includes Cordless and Clutch shades.

| PRICE GROUP E | | WIDTH | | | | | | | | | |
|--|--------|--------------|--------------------|-------|-------|-------|---------|---------|---------|---------|---------|
| | | 24" | 30" | 36" | 42" | 48" | 60" | 72" | 84" | 96" | |
| ARTISAN CATALINA NATURAL ORLEANS PRAIRIE GOLDEN PRAIRIE WHITE REMI RHONE SAYBROOK TWYLA | LENGTH | 36" | \$414 | \$429 | \$470 | \$496 | \$519 | \$665 | \$754 | \$907 | \$1,042 |
| | | 48" | \$426 | \$469 | \$527 | \$560 | \$593 | \$758 | \$866 | \$1,037 | \$1,185 |
| | | 54" | \$447 | \$508 | \$570 | \$600 | \$630 | \$802 | \$921 | \$1,100 | \$1,259 |
| | | 60" | \$466 | \$540 | \$597 | \$638 | \$664 | \$847 | \$976 | \$1,165 | \$1,332 |
| | | 66" | \$486 | \$557 | \$627 | \$663 | \$701 | \$948 | \$1,069 | \$1,258 | \$1,437 |
| | | 72" | \$508 | \$573 | \$639 | \$690 | \$738 | \$989 | \$1,138 | \$1,351 | \$1,540 |
| | | 78" | \$524 | \$597 | \$668 | \$773 | \$794 | \$1,036 | \$1,195 | \$1,419 | \$1,619 |
| | | 84" | \$548 | \$622 | \$696 | \$811 | \$849 | \$1,085 | \$1,252 | \$1,482 | \$1,699 |
| | | 96" | \$590 | \$674 | \$756 | \$819 | \$923 | \$1,233 | \$1,425 | \$1,690 | \$1,930 |
| | | 108" | \$650 | \$745 | \$838 | \$909 | \$1,024 | \$1,369 | \$1,586 | \$1,881 | \$2,150 |
| | | VALANCE ONLY | Maximum Length 18" | \$246 | \$259 | \$291 | \$312 | \$331 | \$420 | \$491 | \$595 |

| PRICE GROUP F | | WIDTH | | | | | | | | | |
|---|--------|--------------|--------------------|-------|---------|---------|---------|---------|---------|---------|---------|
| | | 24" | 30" | 36" | 42" | 48" | 60" | 72" | 84" | 96" | |
| AIRES ANDELL AVON MYKONOS NAVARRE PRAIRIE SNOW SEASIDE ZAHRA | LENGTH | 36" | \$467 | \$515 | \$566 | \$596 | \$654 | \$820 | \$934 | \$1,131 | \$1,279 |
| | | 48" | \$506 | \$571 | \$635 | \$676 | \$717 | \$927 | \$1,058 | \$1,275 | \$1,477 |
| | | 54" | \$532 | \$603 | \$674 | \$721 | \$766 | \$972 | \$1,147 | \$1,374 | \$1,550 |
| | | 60" | \$560 | \$635 | \$708 | \$762 | \$827 | \$1,046 | \$1,203 | \$1,434 | \$1,656 |
| | | 66" | \$588 | \$665 | \$743 | \$799 | \$878 | \$1,119 | \$1,293 | \$1,537 | \$1,761 |
| | | 72" | \$611 | \$695 | \$777 | \$837 | \$921 | \$1,205 | \$1,392 | \$1,654 | \$1,890 |
| | | 78" | \$639 | \$728 | \$816 | \$893 | \$992 | \$1,267 | \$1,463 | \$1,740 | \$1,993 |
| | | 84" | \$663 | \$758 | \$852 | \$949 | \$1,044 | \$1,327 | \$1,536 | \$1,823 | \$2,094 |
| | | 96" | \$713 | \$820 | \$923 | \$1,029 | \$1,151 | \$1,489 | \$1,745 | \$2,047 | \$2,333 |
| | | 108" | \$790 | \$910 | \$1,024 | \$1,145 | \$1,283 | \$1,658 | \$1,945 | \$2,282 | \$2,604 |
| | | VALANCE ONLY | Maximum Length 18" | \$289 | \$327 | \$368 | \$392 | \$439 | \$543 | \$635 | \$774 |

CUSTOM OPTIONS PRICING

| LIGHT-FILTERING LINERS | LENGTH | WIDTH | | | | | | | | |
|---|--------|-------|-------|-------|-------|-------|-------|-------|-------|-------|
| | | 24" | 30" | 36" | 42" | 48" | 60" | 72" | 84" | 96" |
| BEIGE BLACK CHOCOLATE GRAY WHITE Light-filtering liners are the same color on the front and back side. | 36" | \$34 | \$44 | \$52 | \$60 | \$70 | \$86 | \$104 | \$122 | \$139 |
| | 48" | \$45 | \$56 | \$67 | \$78 | \$89 | \$112 | \$134 | \$156 | \$179 |
| | 54" | \$49 | \$61 | \$74 | \$86 | \$100 | \$124 | \$149 | \$173 | \$198 |
| | 60" | \$55 | \$68 | \$82 | \$96 | \$109 | \$137 | \$164 | \$191 | \$218 |
| | 66" | \$60 | \$74 | \$89 | \$104 | \$119 | \$149 | \$179 | \$208 | \$238 |
| | 72" | \$64 | \$81 | \$97 | \$113 | \$128 | \$161 | \$193 | \$225 | \$258 |
| | 78" | \$70 | \$86 | \$104 | \$122 | \$139 | \$173 | \$208 | \$243 | \$277 |
| | 84" | \$74 | \$93 | \$112 | \$130 | \$149 | \$186 | \$223 | \$259 | \$298 |
| | 96" | \$85 | \$105 | \$127 | \$147 | \$168 | \$210 | \$253 | \$295 | \$337 |
| | 108" | \$94 | \$117 | \$141 | \$165 | \$188 | \$235 | \$283 | \$329 | \$377 |

| BLACK-OUT LINERS | LENGTH | WIDTH | | | | | | | | |
|---|--------|-------|-------|-------|-------|-------|-------|-------|-------|-------|
| | | 24" | 30" | 36" | 42" | 48" | 60" | 72" | 84" | 96" |
| BEIGE CHOCOLATE WHITE Black-out liners are off-white to the street side. | 36" | \$37 | \$45 | \$55 | \$64 | \$72 | \$91 | \$109 | \$127 | \$146 |
| | 48" | \$46 | \$59 | \$70 | \$82 | \$94 | \$117 | \$141 | \$164 | \$187 |
| | 54" | \$52 | \$66 | \$78 | \$91 | \$104 | \$130 | \$156 | \$182 | \$209 |
| | 60" | \$57 | \$71 | \$86 | \$100 | \$115 | \$143 | \$172 | \$201 | \$229 |
| | 66" | \$63 | \$78 | \$94 | \$109 | \$126 | \$156 | \$187 | \$218 | \$250 |
| | 72" | \$68 | \$85 | \$101 | \$119 | \$135 | \$169 | \$203 | \$238 | \$270 |
| | 78" | \$72 | \$91 | \$109 | \$127 | \$146 | \$182 | \$218 | \$255 | \$292 |
| | 84" | \$78 | \$98 | \$117 | \$137 | \$156 | \$195 | \$235 | \$273 | \$313 |
| | 96" | \$89 | \$111 | \$132 | \$154 | \$178 | \$221 | \$266 | \$310 | \$354 |
| | 108" | \$98 | \$124 | \$149 | \$173 | \$198 | \$247 | \$296 | \$347 | \$396 |

LINER OPTIONS

MOVABLE LINER (twin shade): \$309 surcharge
 Add surcharge to price of shade with liner.

CUSTOM OPTIONS PRICING

| NARROW TWILL TAPE & RAMIE EDGE BINDING | | WIDTH | | | | | | | | |
|--|------|-------|------|------|------|------|-------|-------|-------|-------|
| | | 24" | 30" | 36" | 42" | 48" | 60" | 72" | 84" | 96" |
| LENGTH | 36" | \$38 | \$40 | \$42 | \$44 | \$46 | \$51 | \$55 | \$59 | \$63 |
| | 48" | \$46 | \$48 | \$51 | \$52 | \$55 | \$59 | \$63 | \$67 | \$71 |
| | 54" | \$51 | \$52 | \$55 | \$56 | \$59 | \$63 | \$67 | \$71 | \$75 |
| | 60" | \$55 | \$56 | \$59 | \$60 | \$63 | \$67 | \$71 | \$75 | \$79 |
| | 66" | \$59 | \$60 | \$63 | \$64 | \$67 | \$71 | \$75 | \$79 | \$83 |
| | 72" | \$63 | \$64 | \$67 | \$68 | \$71 | \$75 | \$79 | \$83 | \$87 |
| | 78" | \$67 | \$68 | \$71 | \$72 | \$75 | \$79 | \$83 | \$87 | \$91 |
| | 84" | \$71 | \$72 | \$75 | \$78 | \$79 | \$83 | \$87 | \$91 | \$96 |
| | 96" | \$79 | \$82 | \$83 | \$86 | \$87 | \$91 | \$96 | \$100 | \$104 |
| | 108" | \$87 | \$90 | \$91 | \$94 | \$96 | \$100 | \$104 | \$108 | \$113 |

| WIDE TWILL TAPE EDGE BINDING | | WIDTH | | | | | | | | |
|------------------------------------|------|-------|-------|-------|-------|-------|-------|-------|-------|-------|
| | | 24" | 30" | 36" | 42" | 48" | 60" | 72" | 84" | 96" |
| LENGTH | 36" | \$49 | \$52 | \$55 | \$57 | \$60 | \$66 | \$71 | \$76 | \$82 |
| | 48" | \$60 | \$63 | \$66 | \$68 | \$71 | \$76 | \$82 | \$87 | \$93 |
| | 54" | \$66 | \$68 | \$71 | \$74 | \$76 | \$82 | \$87 | \$93 | \$98 |
| | 60" | \$71 | \$74 | \$76 | \$79 | \$82 | \$87 | \$93 | \$98 | \$104 |
| | 66" | \$76 | \$79 | \$82 | \$85 | \$87 | \$93 | \$98 | \$104 | \$109 |
| | 72" | \$82 | \$85 | \$87 | \$90 | \$93 | \$98 | \$104 | \$109 | \$115 |
| | 78" | \$87 | \$90 | \$93 | \$96 | \$98 | \$104 | \$109 | \$115 | \$120 |
| | 84" | \$93 | \$96 | \$98 | \$101 | \$104 | \$109 | \$115 | \$120 | \$126 |
| | 96" | \$104 | \$107 | \$109 | \$112 | \$115 | \$120 | \$126 | \$131 | \$137 |
| | 108" | \$115 | \$117 | \$120 | \$123 | \$126 | \$131 | \$137 | \$142 | \$147 |

CUSTOM OPTIONS PRICING

STYLE OPTIONS

CORDLESS TOP-DOWN BOTTOM-UP (TDBU): **\$140**

MULTIPLE SHADES ON ONE HEAD RAIL

Add surcharge to price of two/three separate shades:

2-ON-1: **\$52**

3-ON-1: **\$65**

CUT OUTS (EACH): **\$39**

FABRIC VALANCE RETURNS (MADE OF EDGE BINDING MATERIAL): **\$39**

MOTORIZATION UPGRADES

| MOTORS | |
|---|-------|
| WAND MOTOR | \$235 |
| STANDARD REMOTE MOTOR <i>RECHARGEABLE LITHIUM ION, DC, AND AC STYLES</i> | \$350 |
| POWER LIFT MOTOR <i>RECHARGEABLE LITHIUM ION MOTOR</i> | \$599 |
| CONTROLS, BATTERIES, AND CHARGERS | |
| HAND HELD REMOTE (SINGLE CHANNEL) | \$71 |
| HAND HELD REMOTE (15 CHANNELS) | \$90 |
| WALL SWITCH (SINGLE CHANNEL) | \$126 |
| WALL SWITCH (15 CHANNELS) | \$161 |
| PRO HUB | \$458 |
| RECHARGEABLE LI BATTERY PACK <i>EXTERNAL POWER SUPPLY FOR DC MOTOR</i> | \$120 |
| 6' MICRO-USB CHARGER <i>CHARGES WAND, LI MOTORS, AND LI BATTERY PACK</i> | \$65 |
| 16 1/2' MICRO-USB CHARGER <i>CHARGES LI MOTORS AND LI BATTERY PACK</i> | \$81 |

VALANCE ONLY SURCHARGES

VALANCE ONLY LINER SURCHARGE: **\$38**

VALANCE ONLY EDGE BINDING SURCHARGE: **\$23**

FOLDING DOORS

Folding doors are ideal for large windows or doors and hang vertically from hangers, which slide smoothly inside an aluminum track. All folding doors are provided with a brown or white track. *Check the Materials Reference table for patterns that are available to be made as folding doors.*

STYLE OPTIONS

WOOD BARS

The standard style for folding doors is with wood bars. Wood bars are installed on the left and right side of the individual door panels and include a handle.



Wood Bar Folding Door
with handles



Drapery Style Folding Door
with edge binding

DRAPERLY STYLE

Folding doors can be ordered “drapery style,” which will have edge binding on all four sides of each panel for a softer look.

OPENING OPTIONS

ONE WAY

When open, the material stacks either to the right or the left. Specify on the order form to which side of the door the drapery will stack.

CENTER OPENING (SPLIT DRAW)

The door is made from two panels, which are equal width and meet in the middle. Center opening doors with wood bars will have countersunk magnets on the center opening to hold the doors together when closed.

NOTE: *If you want the material to stack back completely clear of the window for an unobstructed view when the door is open, allow for the width of the stack in the overall width of the door. See Specifications for more details.*



One-Way Right Stack
with wood bars



Center Opening (Split Draw)
with wood bars

FOLDING DOORS

FULLNESS

The standard folding door comes with 5% fullness, which means that it lies nearly flat when fully extended. Folding doors can be ordered with 20% fullness, which gives fuller folds; this is a surcharge option.



5% Fullness



20% Fullness

LINERS

Liners are available in light-filtering and black-out. Liners are attached to the top of the folding door and are secured beneath the wood bars or edge binding.

VALANCE

Standard folding doors come with track and panels. Adding a valance provides a decorative touch. It also conceals the track and hangers, and blocks any light gap between the track and the top of the door fabric.

The valance is 8" long and is mounted to a wooden board that is 5½" deep and ¾" thick. The valance is attached to the front edge of the board by velcro.

The valance is oriented in the same direction as the door (vertically) and is edge-bound on the top and bottom.

For inside mount, the valance will cover the front of the valance board only. For outside mount, the valance will be made to wrap around both ends of the valance board.



Folding Door with Valance
outside mount

FOLDING DOOR SPECIFICATIONS

SIZE LIMITATIONS

Minimum Width: 24"

Maximum Width: 192"^[1]

Minimum Height: 24"

Maximum Height: 96"

^[1] Maximum Width: Tracks and valance boards wider than 90" are spliced to avoid oversize freight charges.

IMPORTANT INFORMATION FOR ORDERING AND INSTALLING FOLDING DOORS

DOORS WITHOUT A VALANCE

For doors without a valance, the height of the folding door is measured from the top of the track to the bottom of the fabric.

There is a gap of approximately $\frac{3}{4}$ " between the top of the track and the material. The factory will deduct this amount from the ordered length when they make the fabric panel.

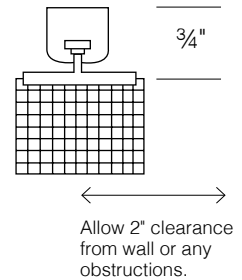

DOORS WITH A VALANCE

For doors with a valance, the height of the folding door is measured from the top of the valance board to the bottom of the fabric.

The valance board is $\frac{3}{4}$ " thick, and there is $\frac{3}{4}$ " between the top of the track and the top of the material. The factory will deduct $1\frac{1}{2}$ " from the ordered length when they make the fabric panel.

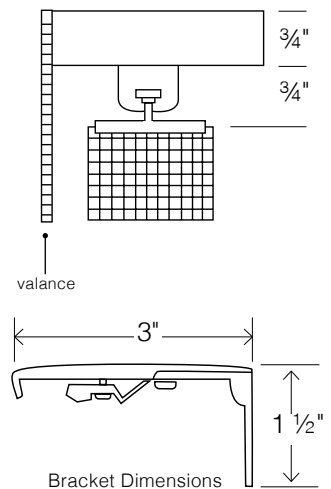

INSIDE MOUNT MEASUREMENTS

Minimum Inside Mount Depth: 2"

Check for any obstructions, such as trim or handles that may interfere with the opening and closing of the door.

Inside Mount Deductions:

Width: $\frac{1}{4}$ "

Height: $\frac{3}{4}$ "

No deductions are made to the width or height of outside mount doors.

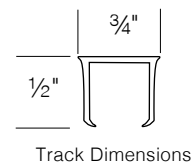

STACKING CHART (5% FULLNESS)

| WIDTH | STACK |
|-------|-------------------|
| 36" | 8 $\frac{1}{2}$ " |
| 42" | 9" |
| 48" | 9 $\frac{1}{2}$ " |
| 60" | 11" |
| 72" | 12" |
| 84" | 13" |
| 96" | 14" |

Center opening (or split draw) folding doors will open into two equal stacks on each side. For example, a 96" center opening will have two stacks each the size of a 48" one-way opening door: 9 $\frac{1}{2}$ ".

20% fullness folding doors will stack approximately 1" wider for small doors and 1 $\frac{1}{2}$ " wider for larger doors than same size at 5% fullness. For example, a 72" width panel will have roughly a 13 $\frac{1}{2}$ " stack.

All stacking dimensions are approximate and will vary by pattern.

FOLDING DOOR PRICING - ONE WAY OPENING

All tracks and valance boards over 90" wide will be spliced to avoid oversize freight charges.

| | | WIDTH | | | | | | | | | | | |
|-----------------------------------|-----|-------|-------|-------|-------|---------|---------|---------|---------|---------|---------|---------|---------|
| PRICE GROUP A | | 48" | 60" | 72" | 84" | 96" | 120" | 132" | 144" | 156" | 168" | 180" | 192" |
| DEVON PENANG SUNSHADE BROWN | 48" | \$382 | \$450 | \$515 | \$596 | \$675 | \$826 | \$902 | \$978 | \$1,054 | \$1,130 | \$1,206 | \$1,282 |
| | 60" | \$426 | \$504 | \$579 | \$669 | \$758 | \$929 | \$1,015 | \$1,101 | \$1,187 | \$1,273 | \$1,359 | \$1,444 |
| | 72" | \$470 | \$557 | \$642 | \$742 | \$841 | \$1,033 | \$1,129 | \$1,224 | \$1,320 | \$1,415 | \$1,511 | \$1,606 |
| | 84" | \$514 | \$611 | \$706 | \$815 | \$923 | \$1,137 | \$1,244 | \$1,350 | \$1,457 | \$1,564 | \$1,671 | \$1,778 |
| | 96" | \$558 | \$665 | \$769 | \$888 | \$1,006 | \$1,240 | \$1,359 | \$1,477 | \$1,595 | \$1,713 | \$1,831 | \$1,950 |
| VALANCE | | \$114 | \$118 | \$150 | \$153 | \$190 | \$236 | \$253 | \$269 | \$285 | \$301 | \$317 | \$334 |

| | | WIDTH | | | | | | | | | | | |
|---|-----|-------|-------|-------|-------|---------|---------|---------|---------|---------|---------|---------|---------|
| PRICE GROUP B | | 48" | 60" | 72" | 84" | 96" | 120" | 132" | 144" | 156" | 168" | 180" | 192" |
| ALDER BAMBOO BARCELONA BORA DRIFTWOOD JAVA TAMARIND | 48" | \$406 | \$480 | \$552 | \$638 | \$723 | \$887 | \$968 | \$1,048 | \$1,129 | \$1,210 | \$1,291 | \$1,372 |
| | 60" | \$456 | \$542 | \$624 | \$722 | \$818 | \$1,005 | \$1,099 | \$1,193 | \$1,287 | \$1,381 | \$1,475 | \$1,569 |
| | 72" | \$507 | \$603 | \$697 | \$806 | \$913 | \$1,124 | \$1,229 | \$1,335 | \$1,440 | \$1,545 | \$1,651 | \$1,756 |
| | 84" | \$557 | \$665 | \$769 | \$890 | \$1,008 | \$1,243 | \$1,360 | \$1,476 | \$1,593 | \$1,709 | \$1,826 | \$1,943 |
| | 96" | \$607 | \$726 | \$842 | \$973 | \$1,104 | \$1,362 | \$1,491 | \$1,621 | \$1,750 | \$1,880 | \$2,010 | \$2,139 |
| VALANCE | | \$127 | \$132 | \$167 | \$172 | \$214 | \$267 | \$287 | \$306 | \$326 | \$345 | \$364 | \$384 |

| | | WIDTH | | | | | | | | | | | |
|-------------------------------------|-----|-------|-------|-------|---------|---------|---------|---------|---------|---------|---------|---------|---------|
| PRICE GROUP C | | 48" | 60" | 72" | 84" | 96" | 120" | 132" | 144" | 156" | 168" | 180" | 192" |
| ASPEN MANDALAY SUNSHADE WHITE | 48" | \$448 | \$532 | \$614 | \$711 | \$807 | \$991 | \$1,080 | \$1,169 | \$1,258 | \$1,347 | \$1,436 | \$1,525 |
| | 60" | \$508 | \$607 | \$702 | \$813 | \$923 | \$1,136 | \$1,241 | \$1,346 | \$1,452 | \$1,557 | \$1,662 | \$1,767 |
| | 72" | \$569 | \$681 | \$791 | \$915 | \$1,039 | \$1,281 | \$1,402 | \$1,524 | \$1,645 | \$1,766 | \$1,888 | \$2,009 |
| | 84" | \$630 | \$756 | \$879 | \$1,017 | \$1,154 | \$1,425 | \$1,560 | \$1,694 | \$1,829 | \$1,963 | \$2,098 | \$2,232 |
| | 96" | \$690 | \$830 | \$967 | \$1,119 | \$1,270 | \$1,570 | \$1,721 | \$1,872 | \$2,022 | \$2,173 | \$2,323 | \$2,474 |
| VALANCE | | \$147 | \$156 | \$194 | \$203 | \$252 | \$298 | \$321 | \$343 | \$366 | \$389 | \$411 | \$434 |

FOLDING DOOR PRICING - ONE WAY OPENING

All tracks and valance boards over 90" wide will be spliced to avoid oversize freight charges.

| | | WIDTH | | | | | | | | | | | | |
|---------------|--------|-------|-------|-------|---------|---------|---------|---------|---------|---------|---------|---------|---------|---------|
| PRICE GROUP D | LENGTH | 48" | 60" | 72" | 84" | 96" | 120" | 132" | 144" | 156" | 168" | 180" | 192" | |
| TELLURIDE | | 48" | \$530 | \$631 | \$727 | \$842 | \$955 | \$1,173 | \$1,279 | \$1,384 | \$1,490 | \$1,595 | \$1,701 | \$1,806 |
| | | 60" | \$602 | \$719 | \$832 | \$963 | \$1,093 | \$1,345 | \$1,470 | \$1,594 | \$1,719 | \$1,844 | \$1,969 | \$2,093 |
| | | 72" | \$674 | \$807 | \$936 | \$1,084 | \$1,230 | \$1,517 | \$1,661 | \$1,804 | \$1,948 | \$2,092 | \$2,236 | \$2,380 |
| | | 84" | \$746 | \$895 | \$1,041 | \$1,205 | \$1,367 | \$1,688 | \$1,847 | \$2,007 | \$2,166 | \$2,325 | \$2,484 | \$2,644 |
| | | 96" | \$818 | \$983 | \$1,145 | \$1,326 | \$1,505 | \$1,860 | \$2,038 | \$2,217 | \$2,395 | \$2,573 | \$2,752 | \$2,930 |
| VALANCE | | \$174 | \$184 | \$230 | \$240 | \$298 | \$353 | \$380 | \$407 | \$434 | \$460 | \$487 | \$514 | |

| | | WIDTH | | | | | | | | | | | | |
|---------------|--------|-------|-------|---------|---------|---------|---------|---------|---------|---------|---------|---------|---------|---------|
| PRICE GROUP E | LENGTH | 48" | 60" | 72" | 84" | 96" | 120" | 132" | 144" | 156" | 168" | 180" | 192" | |
| TWYLA | | 48" | \$634 | \$754 | \$870 | \$1,007 | \$1,143 | \$1,403 | \$1,530 | \$1,656 | \$1,782 | \$1,908 | \$2,034 | \$2,161 |
| | | 60" | \$720 | \$860 | \$995 | \$1,152 | \$1,307 | \$1,609 | \$1,758 | \$1,907 | \$2,056 | \$2,205 | \$2,354 | \$2,503 |
| | | 72" | \$806 | \$965 | \$1,120 | \$1,296 | \$1,471 | \$1,814 | \$1,986 | \$2,158 | \$2,330 | \$2,502 | \$2,674 | \$2,846 |
| | | 84" | \$892 | \$1,071 | \$1,245 | \$1,441 | \$1,635 | \$2,019 | \$2,210 | \$2,400 | \$2,590 | \$2,781 | \$2,971 | \$3,162 |
| | | 96" | \$978 | \$1,176 | \$1,370 | \$1,586 | \$1,799 | \$2,224 | \$2,438 | \$2,651 | \$2,864 | \$3,078 | \$3,291 | \$3,505 |
| VALANCE | | \$208 | \$221 | \$275 | \$287 | \$357 | \$422 | \$454 | \$486 | \$518 | \$551 | \$583 | \$615 | |

| | | WIDTH | | | | | | | | | | | | |
|---------------|--------|-------|---------|---------|---------|---------|---------|---------|---------|---------|---------|---------|---------|---------|
| PRICE GROUP F | LENGTH | 48" | 60" | 72" | 84" | 96" | 120" | 132" | 144" | 156" | 168" | 180" | 192" | |
| ZAHRA | | 48" | \$793 | \$943 | \$1,087 | \$1,259 | \$1,428 | \$1,754 | \$1,912 | \$2,070 | \$2,228 | \$2,385 | \$2,543 | \$2,701 |
| | | 60" | \$900 | \$1,075 | \$1,244 | \$1,440 | \$1,634 | \$2,011 | \$2,197 | \$2,384 | \$2,570 | \$2,757 | \$2,943 | \$3,129 |
| | | 72" | \$1,008 | \$1,206 | \$1,400 | \$1,620 | \$1,839 | \$2,267 | \$2,483 | \$2,698 | \$2,913 | \$3,128 | \$3,343 | \$3,558 |
| | | 84" | \$1,115 | \$1,338 | \$1,556 | \$1,801 | \$2,044 | \$2,524 | \$2,762 | \$3,000 | \$3,238 | \$3,476 | \$3,714 | \$3,952 |
| | | 96" | \$1,222 | \$1,470 | \$1,713 | \$1,982 | \$2,249 | \$2,780 | \$3,047 | \$3,314 | \$3,581 | \$3,847 | \$4,114 | \$4,381 |
| VALANCE | | \$260 | \$276 | \$344 | \$359 | \$446 | \$528 | \$568 | \$608 | \$648 | \$688 | \$728 | \$769 | |

FOLDING DOOR PRICING - ONE WAY OPENING

All tracks and valance boards over 90" wide will be spliced to avoid oversize freight charges.

| | | WIDTH | | | | | | | | | | | | |
|--|--------|-------|-------|-------|-------|-------|-------|-------|-------|-------|-------|-------|-------|-------|
| | | 48" | 60" | 72" | 84" | 96" | 120" | 132" | 144" | 156" | 168" | 180" | 192" | |
| LIGHT-FILTERING LINERS BEIGE BLACK CHOCOLATE GRAY WHITE Light-filtering liners are the same color on the front and back side. | LENGTH | 48" | \$122 | \$144 | \$165 | \$191 | \$217 | \$266 | \$290 | \$315 | \$339 | \$363 | \$387 | \$412 |
| | | 60" | \$137 | \$163 | \$187 | \$217 | \$246 | \$302 | \$330 | \$358 | \$386 | \$414 | \$442 | \$471 |
| | | 72" | \$152 | \$181 | \$209 | \$242 | \$274 | \$337 | \$369 | \$400 | \$432 | \$464 | \$495 | \$527 |
| | | 84" | \$167 | \$199 | \$231 | \$267 | \$303 | \$373 | \$408 | \$443 | \$478 | \$513 | \$548 | \$583 |
| | | 96" | \$182 | \$218 | \$253 | \$292 | \$331 | \$409 | \$447 | \$486 | \$525 | \$564 | \$603 | \$642 |
| VALANCE | | | \$38 | \$40 | \$50 | \$52 | \$64 | \$80 | \$86 | \$92 | \$98 | \$103 | \$109 | \$115 |

| | | WIDTH | | | | | | | | | | | | |
|--|--------|-------|-------|-------|-------|-------|-------|-------|-------|-------|-------|-------|-------|-------|
| | | 48" | 60" | 72" | 84" | 96" | 120" | 132" | 144" | 156" | 168" | 180" | 192" | |
| BLACK-OUT LINERS BEIGE CHOCOLATE WHITE Black-out liners are off-white to the street side. | LENGTH | 48" | \$162 | \$192 | \$221 | \$255 | \$289 | \$355 | \$387 | \$419 | \$452 | \$484 | \$517 | \$549 |
| | | 60" | \$183 | \$217 | \$250 | \$289 | \$327 | \$402 | \$440 | \$477 | \$515 | \$552 | \$590 | \$628 |
| | | 72" | \$203 | \$241 | \$279 | \$322 | \$365 | \$450 | \$492 | \$534 | \$576 | \$618 | \$660 | \$702 |
| | | 84" | \$223 | \$266 | \$308 | \$356 | \$403 | \$497 | \$544 | \$590 | \$637 | \$684 | \$730 | \$777 |
| | | 96" | \$243 | \$290 | \$337 | \$389 | \$441 | \$545 | \$597 | \$648 | \$700 | \$752 | \$804 | \$856 |
| VALANCE | | | \$51 | \$53 | \$67 | \$69 | \$85 | \$107 | \$115 | \$122 | \$130 | \$138 | \$146 | \$154 |

OPTIONS SURCHARGES

FOR 20% FULLNESS, ADD 20% TO STANDARD PRICES.

SPLIT DRAW: **\$157**

NET FREIGHT SURCHARGE*

UP TO 93" LONG: **\$40**

OVER 93" LONG: **\$100**

*Freight surcharge applies for orders shipping within the continental U.S. For orders shipping to Alaska or Hawaii, please request a freight quote prior to placing your order.

SLIDING PANELS

Sliding panels provide a clean, contemporary look for large windows and doors. Overlapping panels are suspended from hangers, which glide smoothly on an aluminum track and pass in front or behind each other, allowing panels to stack away from the window.

Panels are attached to the track and include edge binding to protect them from wear and tear. Panels are custom-sized, based on the ordered width and the number of panels.

Check the Materials Reference table for patterns that are available to be made as sliding panels.

NOTE: Because bamboo and natural materials can stretch or shrink, we recommend that panels are ordered with at least $\frac{3}{4}$ " clearance from the ground. When shipped from the factory, panels may be slightly different lengths (up to $\frac{1}{2}$ " from the ordered length). A shorter panel can be corrected by gently pulling on the bottom of the panel until it is the same length as longer panels.

OPENING OPTIONS

ONE WAY

When open, all panels stack to either the right or the left. *Specify on the order to which side of the window the panels will stack.*

The standard configuration is for the back panel to be stationary and all the other panels stack in front. Reverse stacking is available, with the front panel stationary. Free-floating panels are also available.

CENTER OPENING (SPLIT DRAW)

Must be made with an even number of panels. Panels stack to both sides.

When made with four panels, the front left and back right panels are stationary. If made with six or eight panels, the back panels on both sides will be stationary, and all other panels will stack in front on both sides. See Sliding Panel Configurations on page 31.

Reverse stacking and free-floating panels are also available.

NOTE: *If you want the panels to stack completely away from the window for an unobstructed view, allow for the panel width in the overall width of the shade. See Specifications for more details.*



One-Way Right Stack



Center Opening (Split Draw)

SLIDING PANEL OPTIONS

EDGE BINDING

Panels will come with edge binding as standard. Edge binding will show ½" on the face of the panels.



Edge Binding

LINERS

Liners are available in light-filtering and black-out. They are sewn under the edge binding on all four panel sides.

VALANCE

Valances are 8" long and attached to the front and sides of the track by velcro.

Valances are cut up the roll, so they can wrap around the ends of the track. This means the valance material is railroaded and will be oriented differently to the panels. For inside mount sliding panels, the valance will cover the front of the track only. For outside mount sliding panels, the valance will be made to wrap around both ends of the track.

If a valance is part of the original sliding panel order, the velcro for the valance will be riveted to the front of the track to ensure a lasting bond. When ordered separately, both velcro halves are provided, but the bond between the velcro and the track will not be as durable.



Valance
outside mount

SLIDING PANEL SPECIFICATIONS

SIZE LIMITATIONS

Minimum Width: 48" Minimum Height: 24"
 Maximum Width: 192"⁽¹⁾ Maximum Height: 120"

⁽¹⁾ Maximum Width: Tracks wider than 90" are spliced to avoid over-size freight charges.

STANDARD PANEL CONFIGURATIONS

| WIDTH | TYPE OF OPENING | # OF PANELS | TRACK TYPE |
|-----------------|-----------------|-------------|------------|
| 48" – 84" | One-Way | 3 Panels | 3 Channel |
| | Center Opening | 2 Panels | 2 Channel |
| 84 1/4" – 120" | One-Way | 4 Panels | 4 Channel |
| | Center Opening | 4 Panels | 2 Channel |
| 120 1/4" – 144" | One-Way | 5 Panels | 5 Channel |
| | Center Opening | 6 Panels | 3 Channel |

TYPICAL PANEL SIZES

| WIDTH | ONE-WAY DRAW | | CENTER OPENING | |
|-------|--------------|---------|----------------|---------|
| 60" | 3 panels | 21 5/8" | 4 panels | 16 7/8" |
| 72" | 3 panels | 25 5/8" | 4 panels | 19 7/8" |
| 84" | 3 panels | 29 5/8" | 4 panels | 22 7/8" |
| 96" | 4 panels | 25 7/8" | 4 panels | 25 7/8" |
| 108" | 4 panels | 28 7/8" | 4 panels | 28 7/8" |
| 120" | 4 panels | 31 7/8" | 4 panels | 31 7/8" |
| 132" | 5 panels | 28 3/8" | 6 panels | 24 1/8" |
| 144" | 5 panels | 30 3/4" | 6 panels | 26 1/4" |

PANEL SIZE CALCULATIONS

To calculate the approximate panel width, use the ordered width and the number of panels.

Deduct one from the number of panels and multiply this number by 2.5. Then add this number to the ordered width and divide the resulting number by the number of panels.

For example: For a sliding panel order with an 80" width and 5 panels, each panel will be approximately 18" wide.

$$5 \text{ (panels)} - 1 = 4$$

$$4 \times 2.5 = 10"$$

$$80" \text{ (ordered width)} + 10" = 90"$$

$$90" / 5 \text{ (panels)} = 18" \text{ approximate panel width}$$

TRACK DIMENSIONS

| TRACK DEPTHS | |
|--------------|--------|
| 3 Channel | 2" |
| 4 Channel | 2 3/4" |
| 5 Channel | 3 3/8" |

The distance from the top of the track to the top of the panels is 1". The factory will take account of this distance when calculating the panel length.

MOUNTING DEPTHS

| | 3 TRACK | 4 TRACK | 5 TRACK |
|------------|---------|---------|---------|
| Minimum IB | 2" | 2 3/4" | 3 3/8" |
| Flush IB | 2 1/2" | 3 1/4" | 3 7/8" |

Wall or Face Mount: 1 3/4" flat mounting surface required. (Using L Bracket)

INSIDE MOUNT DEDUCTIONS

IB Deduction (Width): 1/4"

IB Deduction (Height): 1/2"

CLEARANCE

Distance from the wall to the back of the track

| | 3-CHANNEL TRACK | 4-CHANNEL TRACK | 5-CHANNEL TRACK |
|---------------------------|-----------------|-----------------|-----------------|
| Standard Bracket (2 7/8") | 1 3/8" | 1 1/4" | 3/4" |
| Large Bracket (4 1/4") | 2 1/2" | 2 3/8" | 1 7/8" |

Adding an extension bracket will provide an extra 2 7/8" of clearance from the wall.

Add the track depth to the clearance to calculate the total projection into the room.

SLIDING PANEL BRACKET

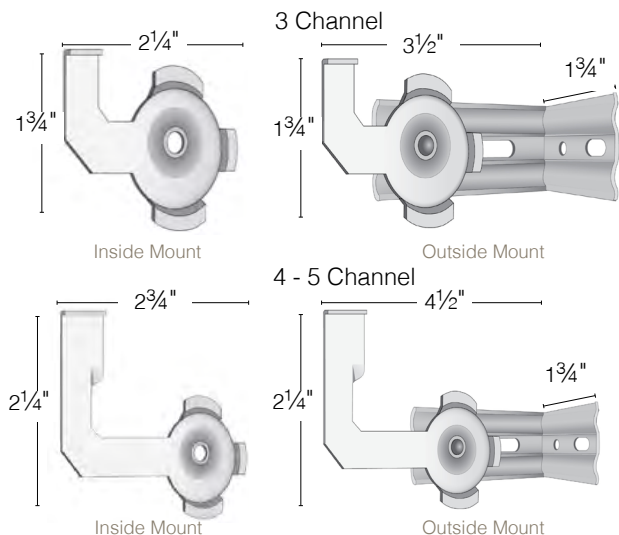

SLIDING PANEL CONFIGURATIONS

GENERAL OPERATION

Open

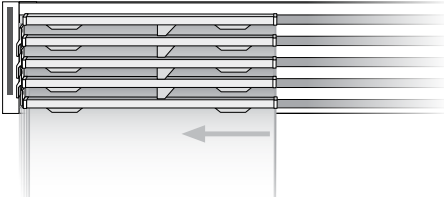

Closed

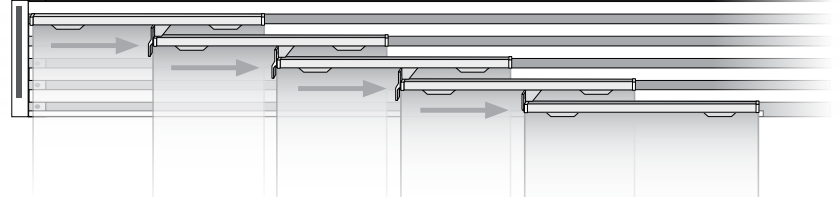

ONE-WAY CONFIGURATIONS

3 Channel Track / 3 Panels / One Way Left

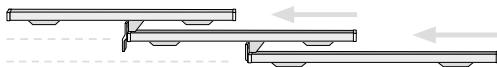

3 Channel Track / 3 Panels / One Way Right

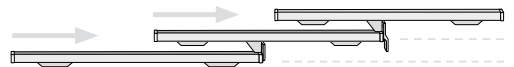

4 Channel Track / 4 Panels / One Way Left

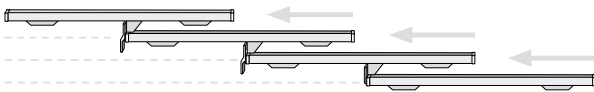

4 Channel Track / 4 Panels / One Way Right

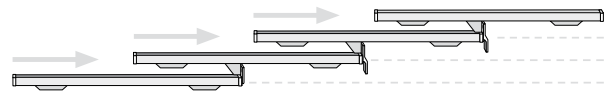

5 Channel Track / 5 Panels / One Way Left

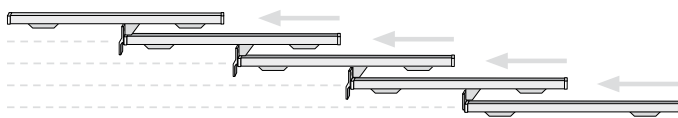

5 Channel Track / 5 Panels / One Way Right

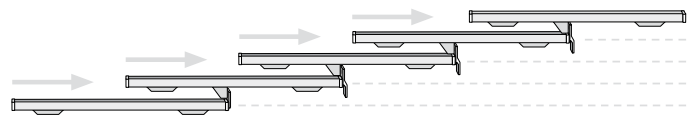

CENTER-SPLIT CONFIGURATIONS

2 Channel Track / 4 Panels / Center Split
stationary front left and back right

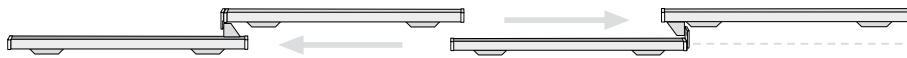

4 Channel Track / 6 Panels / Center Split

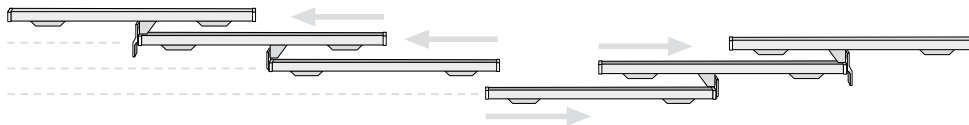

5 Channel Track / 8 Panels / Center Split

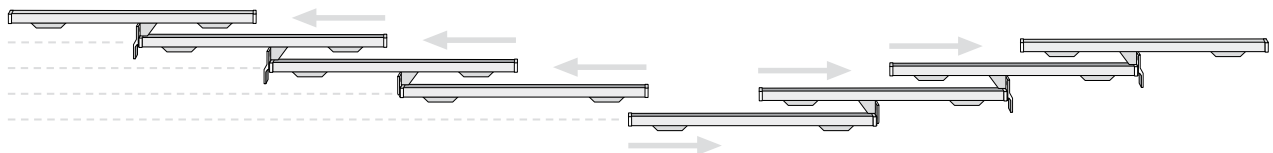

SLIDING PANEL PRICING

All tracks over 90" wide will be spliced to avoid oversize freight charges.

WIDTH

| PRICE GROUP A | LENGTH | WIDTH | | | | | | | | | | | |
|-----------------------------------|--------|---------|---------|---------|---------|---------|---------|---------|---------|---------|---------|---------|---------|
| | | 60" | 72" | 84" | 96" | 108" | 120" | 132" | 144" | 156" | 168" | 180" | 192" |
| DEVON PENANG SUNSHADE BROWN | 60" | \$659 | \$742 | \$831 | \$941 | \$1,024 | \$1,113 | \$1,202 | \$1,279 | \$1,386 | \$1,493 | \$1,599 | \$1,706 |
| | 72" | \$713 | \$804 | \$902 | \$1,025 | \$1,116 | \$1,214 | \$1,314 | \$1,400 | \$1,517 | \$1,634 | \$1,751 | \$1,867 |
| | 84" | \$767 | \$867 | \$974 | \$1,108 | \$1,208 | \$1,315 | \$1,427 | \$1,521 | \$1,648 | \$1,775 | \$1,902 | \$2,029 |
| | 96" | \$822 | \$930 | \$1,045 | \$1,192 | \$1,300 | \$1,415 | \$1,539 | \$1,642 | \$1,779 | \$1,916 | \$2,053 | \$2,190 |
| | 108" | \$925 | \$1,046 | \$1,176 | \$1,341 | \$1,463 | \$1,592 | \$1,732 | \$1,848 | \$2,002 | \$2,156 | \$2,310 | \$2,464 |
| | 120" | \$1,027 | \$1,163 | \$1,306 | \$1,490 | \$1,625 | \$1,769 | \$1,924 | \$2,053 | \$2,224 | \$2,395 | \$2,566 | \$2,737 |
| VALANCE | | \$47 | \$56 | \$66 | \$75 | \$85 | \$94 | \$104 | \$113 | \$122 | \$132 | \$141 | \$151 |

WIDTH

| PRICE GROUP B | LENGTH | WIDTH | | | | | | | | | | | |
|---|--------|---------|---------|---------|---------|---------|---------|---------|---------|---------|---------|---------|---------|
| | | 60" | 72" | 84" | 96" | 108" | 120" | 132" | 144" | 156" | 168" | 180" | 192" |
| ALDER BAMBOO BARCELONA BORA DRIFTWOOD JAVA TAMARIND | 60" | \$673 | \$759 | \$851 | \$964 | \$1,049 | \$1,141 | \$1,232 | \$1,313 | \$1,422 | \$1,532 | \$1,641 | \$1,750 |
| | 72" | \$731 | \$825 | \$926 | \$1,052 | \$1,147 | \$1,248 | \$1,351 | \$1,441 | \$1,561 | \$1,681 | \$1,801 | \$1,921 |
| | 84" | \$788 | \$891 | \$1,001 | \$1,140 | \$1,244 | \$1,354 | \$1,470 | \$1,568 | \$1,699 | \$1,830 | \$1,960 | \$2,091 |
| | 96" | \$845 | \$958 | \$1,077 | \$1,229 | \$1,341 | \$1,460 | \$1,588 | \$1,696 | \$1,837 | \$1,978 | \$2,120 | \$2,261 |
| | 108" | \$951 | \$1,077 | \$1,211 | \$1,382 | \$1,509 | \$1,643 | \$1,787 | \$1,908 | \$2,067 | \$2,226 | \$2,385 | \$2,544 |
| | 120" | \$1,057 | \$1,197 | \$1,346 | \$1,536 | \$1,677 | \$1,825 | \$1,985 | \$2,120 | \$2,296 | \$2,473 | \$2,650 | \$2,826 |
| VALANCE | | \$49 | \$59 | \$69 | \$79 | \$89 | \$99 | \$108 | \$118 | \$128 | \$138 | \$148 | \$158 |

WIDTH

| PRICE GROUP C | LENGTH | WIDTH | | | | | | | | | | | |
|--|--------|---------|---------|---------|---------|---------|---------|---------|---------|---------|---------|---------|---------|
| | | 60" | 72" | 84" | 96" | 108" | 120" | 132" | 144" | 156" | 168" | 180" | 192" |
| ASPEN MANDALAY SAKURA SAVANNA SUNSHADE WHITE | 60" | \$686 | \$774 | \$869 | \$984 | \$1,072 | \$1,166 | \$1,260 | \$1,343 | \$1,454 | \$1,566 | \$1,678 | \$1,790 |
| | 72" | \$746 | \$844 | \$947 | \$1,077 | \$1,174 | \$1,278 | \$1,384 | \$1,476 | \$1,599 | \$1,722 | \$1,845 | \$1,968 |
| | 84" | \$806 | \$913 | \$1,026 | \$1,169 | \$1,276 | \$1,389 | \$1,508 | \$1,610 | \$1,744 | \$1,878 | \$2,012 | \$2,146 |
| | 96" | \$866 | \$982 | \$1,105 | \$1,262 | \$1,378 | \$1,500 | \$1,632 | \$1,743 | \$1,889 | \$2,034 | \$2,179 | \$2,324 |
| | 108" | \$974 | \$1,105 | \$1,243 | \$1,419 | \$1,550 | \$1,688 | \$1,836 | \$1,961 | \$2,125 | \$2,288 | \$2,452 | \$2,615 |
| | 120" | \$1,083 | \$1,228 | \$1,381 | \$1,577 | \$1,722 | \$1,876 | \$2,040 | \$2,179 | \$2,361 | \$2,542 | \$2,724 | \$2,906 |
| VALANCE | | \$51 | \$62 | \$72 | \$82 | \$92 | \$103 | \$113 | \$123 | \$133 | \$144 | \$154 | \$164 |

SLIDING PANEL PRICING

All tracks over 90" wide will be spliced to avoid oversize freight charges.

| PRICE GROUP D | | WIDTH | | | | | | | | | | | |
|--------------------|------------|---------|---------|---------|---------|---------|---------|---------|---------|---------|---------|---------|---------|
| | | 60" | 72" | 84" | 96" | 108" | 120" | 132" | 144" | 156" | 168" | 180" | 192" |
| CAPRI TELLURIDE | LENGTH 60" | \$730 | \$826 | \$928 | \$1,053 | \$1,149 | \$1,251 | \$1,352 | \$1,443 | \$1,563 | \$1,683 | \$1,803 | \$1,924 |
| | 72" | \$799 | \$906 | \$1,019 | \$1,159 | \$1,266 | \$1,379 | \$1,495 | \$1,596 | \$1,729 | \$1,862 | \$1,995 | \$2,128 |
| | 84" | \$868 | \$985 | \$1,109 | \$1,266 | \$1,383 | \$1,507 | \$1,637 | \$1,750 | \$1,896 | \$2,042 | \$2,187 | \$2,333 |
| | 96" | \$936 | \$1,065 | \$1,200 | \$1,372 | \$1,500 | \$1,636 | \$1,780 | \$1,904 | \$2,062 | \$2,221 | \$2,379 | \$2,538 |
| | 108" | \$1,053 | \$1,198 | \$1,350 | \$1,543 | \$1,688 | \$1,840 | \$2,002 | \$2,141 | \$2,320 | \$2,498 | \$2,677 | \$2,855 |
| | 120" | \$1,170 | \$1,331 | \$1,500 | \$1,715 | \$1,876 | \$2,045 | \$2,225 | \$2,379 | \$2,578 | \$2,776 | \$2,974 | \$3,173 |
| VALANCE | | \$58 | \$70 | \$81 | \$93 | \$104 | \$116 | \$128 | \$139 | \$151 | \$162 | \$174 | \$186 |

| PRICE GROUP E | | WIDTH | | | | | | | | | | | |
|---|------------|---------|---------|---------|---------|---------|---------|---------|---------|---------|---------|---------|---------|
| | | 60" | 72" | 84" | 96" | 108" | 120" | 132" | 144" | 156" | 168" | 180" | 192" |
| CATALINA NATURAL PRAIRIE GOLDEN PRAIRIE WHITE REMI SAYBROOK TWYLA | LENGTH 60" | \$824 | \$932 | \$1,047 | \$1,188 | \$1,296 | \$1,411 | \$1,525 | \$1,627 | \$1,763 | \$1,899 | \$2,034 | \$2,170 |
| | 72" | \$901 | \$1,021 | \$1,149 | \$1,308 | \$1,428 | \$1,556 | \$1,686 | \$1,801 | \$1,951 | \$2,101 | \$2,251 | \$2,401 |
| | 84" | \$979 | \$1,111 | \$1,251 | \$1,428 | \$1,560 | \$1,700 | \$1,847 | \$1,974 | \$2,138 | \$2,303 | \$2,467 | \$2,632 |
| | 96" | \$1,056 | \$1,201 | \$1,354 | \$1,547 | \$1,692 | \$1,845 | \$2,008 | \$2,147 | \$2,326 | \$2,505 | \$2,684 | \$2,863 |
| | 108" | \$1,188 | \$1,351 | \$1,523 | \$1,741 | \$1,904 | \$2,076 | \$2,259 | \$2,416 | \$2,617 | \$2,818 | \$3,019 | \$3,221 |
| | 120" | \$1,320 | \$1,502 | \$1,692 | \$1,934 | \$2,116 | \$2,306 | \$2,510 | \$2,684 | \$2,908 | \$3,131 | \$3,355 | \$3,579 |
| VALANCE | | \$66 | \$79 | \$92 | \$105 | \$118 | \$131 | \$144 | \$157 | \$170 | \$183 | \$197 | \$210 |

| PRICE GROUP F | | WIDTH | | | | | | | | | | | |
|---|------------|---------|---------|---------|---------|---------|---------|---------|---------|---------|---------|---------|---------|
| | | 60" | 72" | 84" | 96" | 108" | 120" | 132" | 144" | 156" | 168" | 180" | 192" |
| ARIES MYKONOS NAVARRE PRAIRIE SNOW SEASIDE ZAHRA | LENGTH 60" | \$1,112 | \$1,258 | \$1,413 | \$1,604 | \$1,749 | \$1,905 | \$2,059 | \$2,197 | \$2,380 | \$2,563 | \$2,746 | \$2,929 |
| | 72" | \$1,217 | \$1,379 | \$1,551 | \$1,765 | \$1,928 | \$2,100 | \$2,276 | \$2,431 | \$2,633 | \$2,836 | \$3,039 | \$3,241 |
| | 84" | \$1,321 | \$1,500 | \$1,689 | \$1,927 | \$2,106 | \$2,296 | \$2,493 | \$2,665 | \$2,887 | \$3,109 | \$3,331 | \$3,553 |
| | 96" | \$1,426 | \$1,622 | \$1,828 | \$2,089 | \$2,285 | \$2,491 | \$2,710 | \$2,899 | \$3,140 | \$3,382 | \$3,623 | \$3,865 |
| | 108" | \$1,604 | \$1,824 | \$2,056 | \$2,350 | \$2,570 | \$2,802 | \$3,049 | \$3,261 | \$3,533 | \$3,805 | \$4,076 | \$4,348 |
| | 120" | \$1,782 | \$2,027 | \$2,284 | \$2,611 | \$2,856 | \$3,114 | \$3,388 | \$3,623 | \$3,925 | \$4,227 | \$4,529 | \$4,831 |
| VALANCE | | \$88 | \$106 | \$124 | \$142 | \$159 | \$177 | \$195 | \$212 | \$230 | \$248 | \$265 | \$283 |

SLIDING PANEL PRICING

All tracks over 90" wide will be spliced to avoid oversize freight charges.

| | | WIDTH | | | | | | | | | | | | |
|--|--------|-------|-------|-------|-------|-------|-------|-------|-------|-------|-------|-------|-------|-------|
| | | 60" | 72" | 84" | 96" | 108" | 120" | 132" | 144" | 156" | 168" | 180" | 192" | |
| LIGHT-FILTERING LINERS BEIGE BLACK CHOCOLATE GRAY WHITE Light-filtering liners are the same color on the front and back side. | LENGTH | 60" | \$202 | \$228 | \$255 | \$289 | \$315 | \$342 | \$370 | \$394 | \$427 | \$460 | \$492 | \$525 |
| | | 72" | \$219 | \$248 | \$278 | \$316 | \$344 | \$374 | \$405 | \$432 | \$468 | \$504 | \$540 | \$576 |
| | | 84" | \$236 | \$267 | \$300 | \$342 | \$373 | \$406 | \$441 | \$470 | \$510 | \$549 | \$588 | \$627 |
| | | 96" | \$254 | \$287 | \$323 | \$369 | \$402 | \$438 | \$477 | \$509 | \$551 | \$594 | \$636 | \$678 |
| | | 108" | \$285 | \$323 | \$363 | \$415 | \$453 | \$493 | \$536 | \$572 | \$620 | \$668 | \$715 | \$763 |
| | | 120" | \$317 | \$359 | \$404 | \$461 | \$503 | \$548 | \$596 | \$636 | \$689 | \$742 | \$795 | \$848 |
| VALANCE | | \$15 | \$18 | \$21 | \$24 | \$27 | \$30 | \$33 | \$35 | \$38 | \$41 | \$44 | \$47 | |

| | | WIDTH | | | | | | | | | | | | |
|--|--------|-------|-------|-------|-------|-------|-------|-------|-------|-------|-------|-------|---------|---------|
| | | 60" | 72" | 84" | 96" | 108" | 120" | 132" | 144" | 156" | 168" | 180" | 192" | |
| BLACK-OUT LINERS BEIGE CHOCOLATE WHITE Black-out liners are off-white to the street side. | LENGTH | 60" | \$269 | \$304 | \$340 | \$385 | \$420 | \$457 | \$493 | \$525 | \$569 | \$613 | \$656 | \$700 |
| | | 72" | \$292 | \$330 | \$370 | \$421 | \$459 | \$499 | \$540 | \$576 | \$624 | \$672 | \$720 | \$768 |
| | | 84" | \$315 | \$357 | \$401 | \$456 | \$498 | \$542 | \$588 | \$627 | \$680 | \$732 | \$784 | \$836 |
| | | 96" | \$338 | \$383 | \$431 | \$492 | \$537 | \$584 | \$635 | \$678 | \$735 | \$791 | \$848 | \$904 |
| | | 108" | \$380 | \$431 | \$485 | \$553 | \$604 | \$657 | \$715 | \$763 | \$827 | \$890 | \$954 | \$1,018 |
| | | 120" | \$423 | \$479 | \$538 | \$614 | \$671 | \$730 | \$794 | \$848 | \$919 | \$989 | \$1,060 | \$1,131 |
| VALANCE | | \$20 | \$24 | \$28 | \$32 | \$35 | \$39 | \$43 | \$47 | \$51 | \$55 | \$59 | \$63 | |

OPTIONS AND FREIGHT SURCHARGES

WIDE EDGE BINDING: **\$226**

NET FREIGHT SURCHARGE*

UP TO 93" LONG: **\$40**

**Freight surcharge applies for orders shipping within the continental U.S. For orders shipping to Alaska or Hawaii, please request a freight quote prior to placing your order.*

PRO DESIGN WOVEN WOOD WARRANTY

LIMITED LIFETIME WARRANTY

This product is warranted against defects in materials and workmanship, provided that:

1. The product was installed according to the product instructions.
2. Pro Design LLC recommendations were followed regarding limitations and specifications of the product.

Pro Design LLC reserves the right to determine if your shade warrants a repair or partial replacement of any parts. If necessary, Pro Design LLC will replace your shade with a new shade of equal or superior value. This shall be your sole remedy under this warranty.

This Limited Lifetime Warranty excludes all motors, controls and accessories, which are warranted for only a period of five years from the date of purchase. Failure to follow the proper installation, charging and use instructions will invalidate the warranty for motors, remotes, wands and hubs.

This Limited Lifetime Warranty applies only to the original retail purchaser with proof of purchase.

This Limited Lifetime Warranty does not cover the removal or installation of original or replacement shades. This Limited Lifetime Warranty does not cover damage or defects caused by, or resulting from improper maintenance, neglect or improper use, wear and tear, abuse, neglect, accidents, alteration, commercial use, installation, removal or reinstallation or exposure to excessive moisture.

YOUR RIGHTS UNDER STATE LAW

These warranties give you specific legal rights. You may also have other rights which may vary from State to State. In no event shall Pro Design LLC be liable for incidental or consequential damages or for any other direct or indirect damage, loss, cost, expense or fee. Some states do not allow the exclusion or limitation of incidental or consequential damages, so the above limitation or exclusion may not apply to you. These warranties are exclusive and in lieu of all other obligations, liabilities, disclaimers, or warranties.

WALDEN PREMIER

⚠️ WARNING

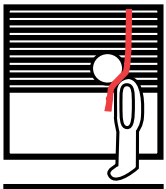

Window Blind Cord Strangulation Risk

Window blinds with a damaged or loose tension device or retractable cord that fails to fully retract pose a strangulation risk to children. To avoid this potential strangulation risk, consider purchasing cordless products with inaccessible cords.

ANSI/WCMA A100.1-2022

⚠️ ADVERTENCIA

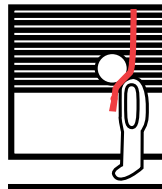

Riesgo de Estrangulamiento en Cuerdas de Persianas

Las persianas con un dispositivo tensor suelto o dañado o con una cuerda retráctable que no se ajusta completamente representan un riesgo de estrangulación para los niños. Para evitar un posible riesgo de estrangulamiento, considere comprar productos inalámbricos o productos con cuerdas inaccesibles.

ANSI/WCMA A100.1-2022